

15 Degree Tilt Racking kits for 25KTL and 50/60KTL

To provide racking solutions for mounting CPS inverters on rooftops, CPS has developed custom tilt racking kits for our 23KTL, 25KTL, 28KTL, 36KTL, and 50/60KTL inverters. The racks will enable the inverters to be mounted “almost flat” with a 15 degree tilt angle from the horizontal line.

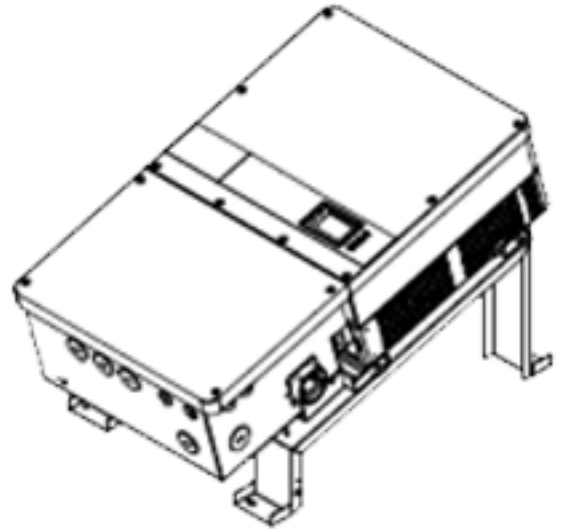

Two parts available:

- SR-25 kit for 1000V applications in the CPS 25kW inverters. This kit includes the shade cover.
- SR-60 for 1000V applications in the CPS 23, 28, 36, and 50/60kW inverters. This kit does not include the shade cover.

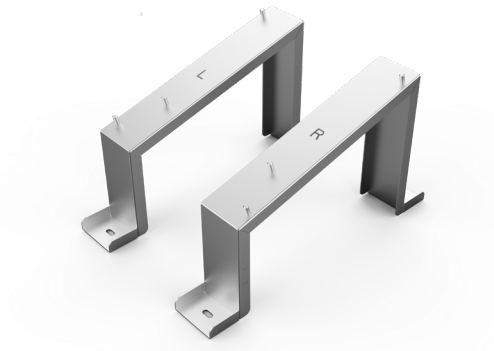

25kW Rack

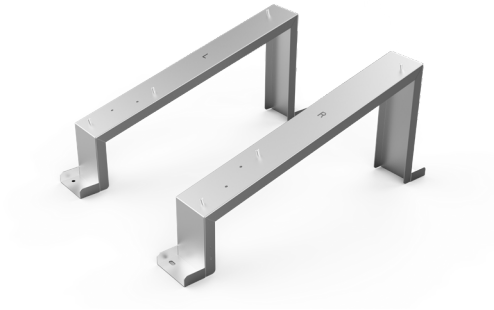
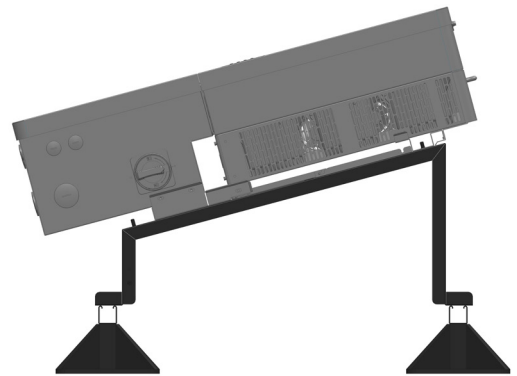

36/50/60kW Rack

15 Degree Tilt Racking kits for 25KTL and 50/60KTL

Mechanical Drawings

**SR-25
(For 25kW Inverter)**

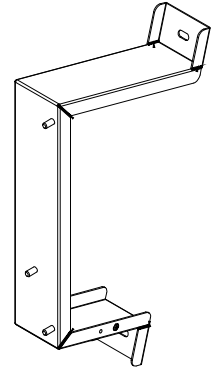
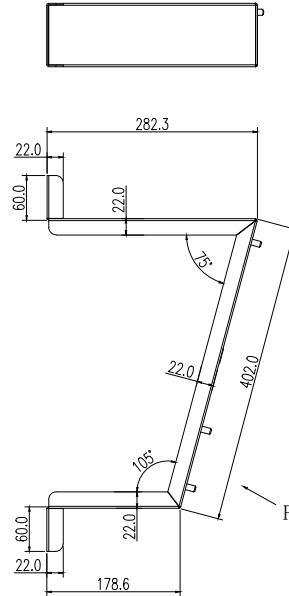
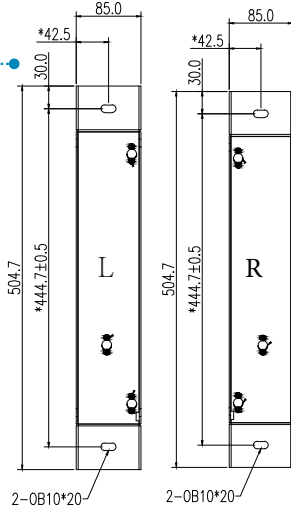

Shade Cover for SR-25 Kit

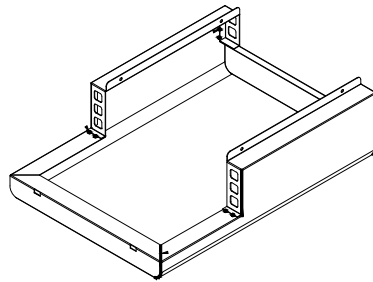
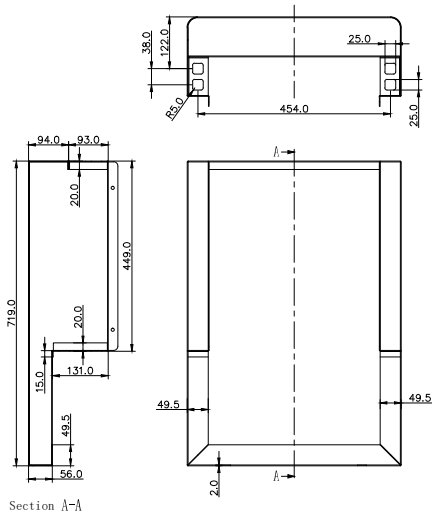

**SR-60
(For 23/28/36/50/60kW inverters)**

